



Installation instructions, accessories

Volvo Car Corporation Gothenburg, Sweden

Instruction No	Version	Part. No.
31470000	1.2	31435694

Dirt cover, load compartment, fully covering



Installation instructions, accessories

Volvo Car Corporation Gothenburg, Sweden

Equipment



IMG-405465

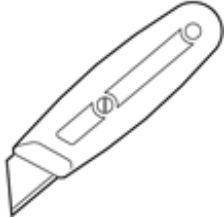

IMG-239980

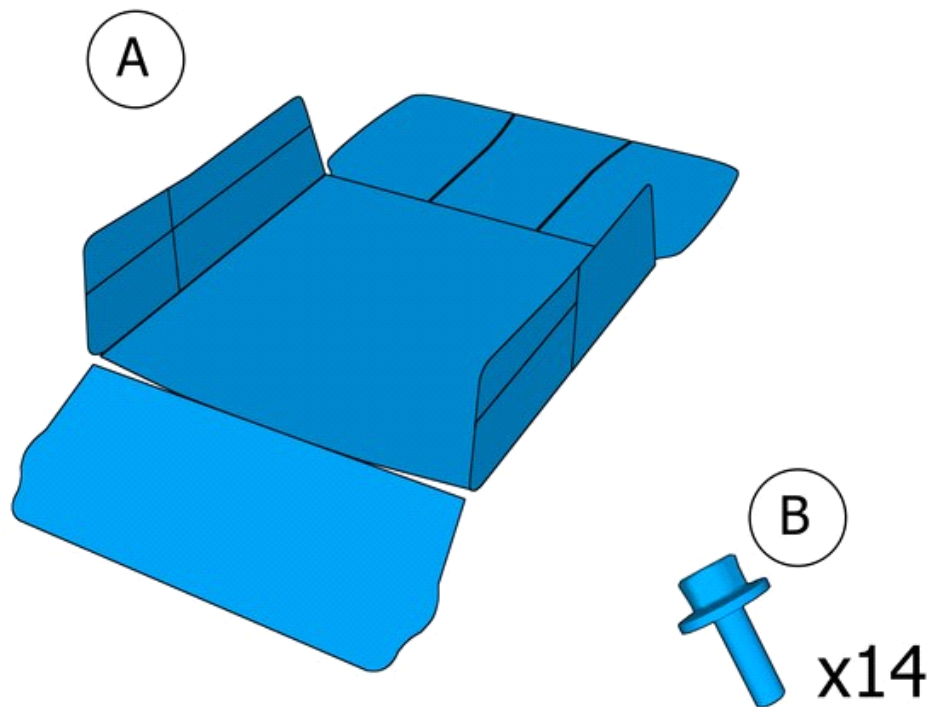

IMG-405712



Installation instructions, accessories

Volvo Car Corporation Gothenburg, Sweden

Information

1

Read through all of the instructions before starting installation.

Notifications and warning texts are for your safety and to minimise the risk of something breaking during installation.

Ensure that all tools stated in the instructions are available before starting installation.

Certain steps in the instructions are only presented in the form of images. Explanatory text is also given for more complicated steps.

In the event of any problems with the instructions or the accessory, contact your local Volvo dealer.

Color symbols

2

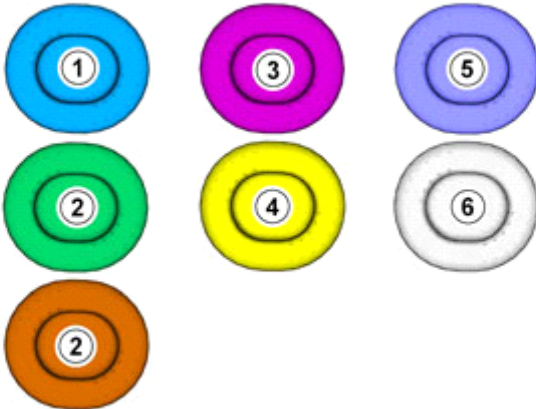

IMG-363036

Note!

This colour chart displays (in colour print and electronic version) the importance of the different colours used in the images of the method steps.

1. Used for focused component, the component with which you will do something.
2. Used as extra colors when you need to show or differentiate additional parts.
3. Used for attachments that are to be removed/installed. May be screws, clips, connectors, etc.
4. Used when the component is not fully removed from the vehicle but only hung to the side.
5. Used for standard tools and special tools.
6. Used as background color for vehicle components.

Preparation



Installation instructions, accessories

Volvo Car Corporation Gothenburg, Sweden

3

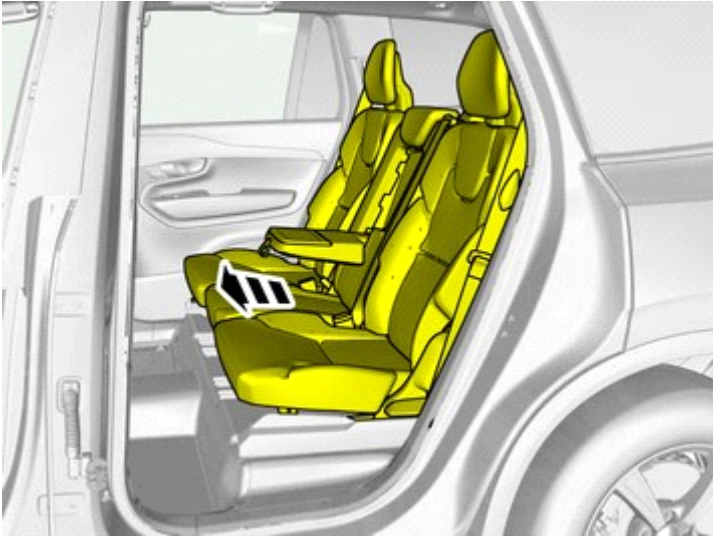

IMG-408845

4

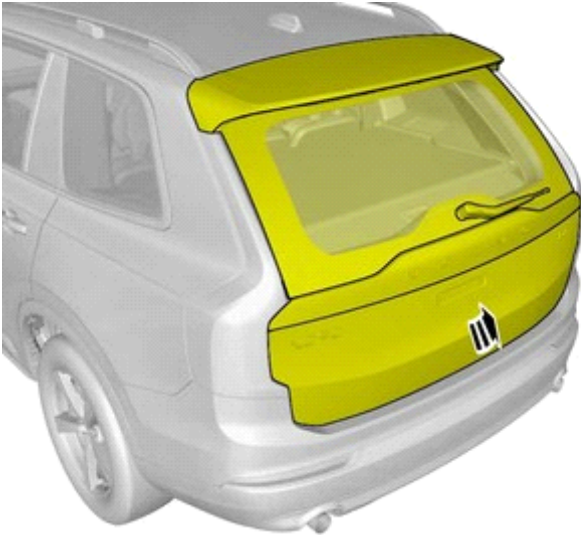

IMG-394779

Open the tailgate.

Accessory installation



Installation instructions, accessories

Volvo Car Corporation Gothenburg, Sweden

5

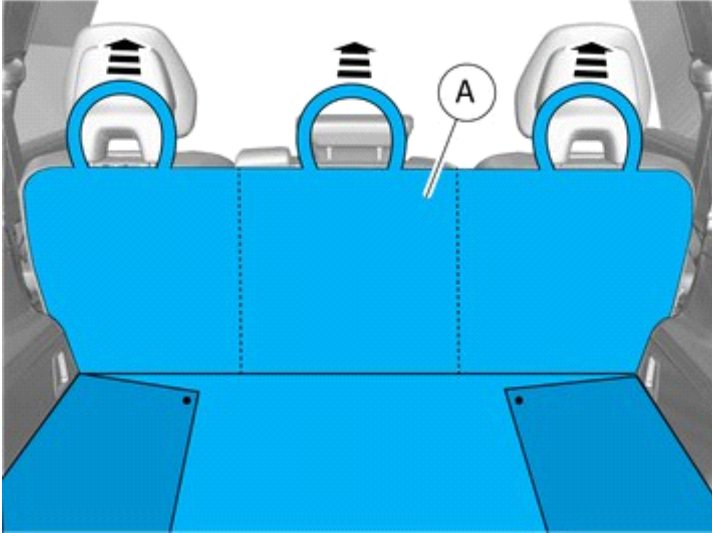

IMG-408846

Install component that comes with the accessory kit.

6

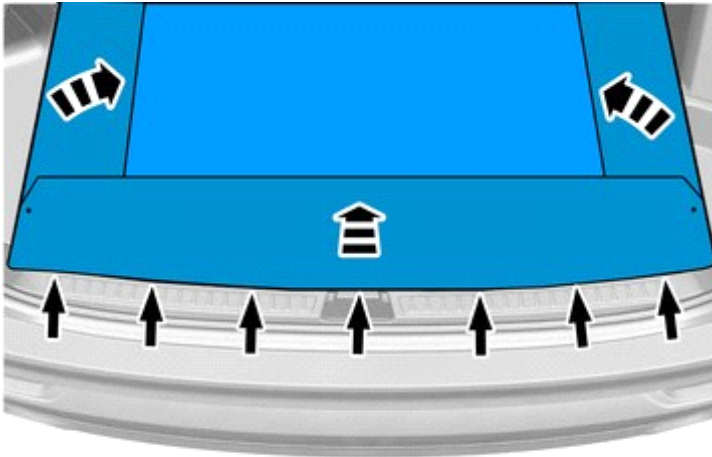

IMG-408847

Place the component where indicated in the graphic.

7

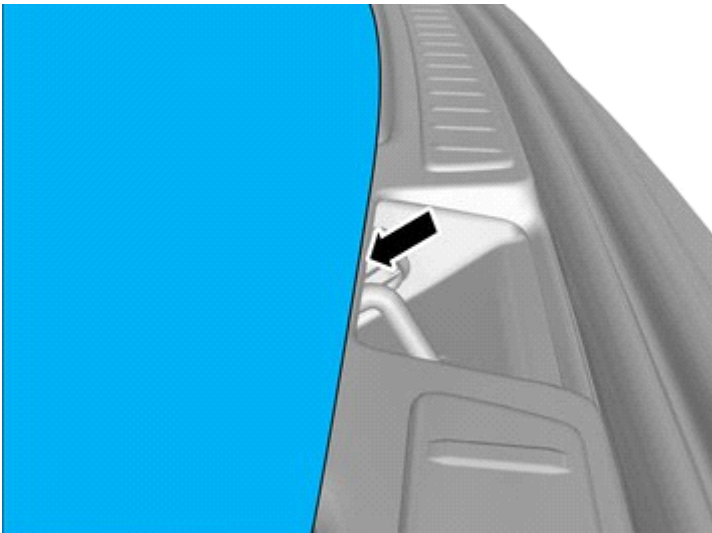

IMG-408848

Note!
Note the position.

Place the component where indicated in the graphic.



Installation instructions, accessories

Volvo Car Corporation Gothenburg, Sweden

Applies to the left-hand side:

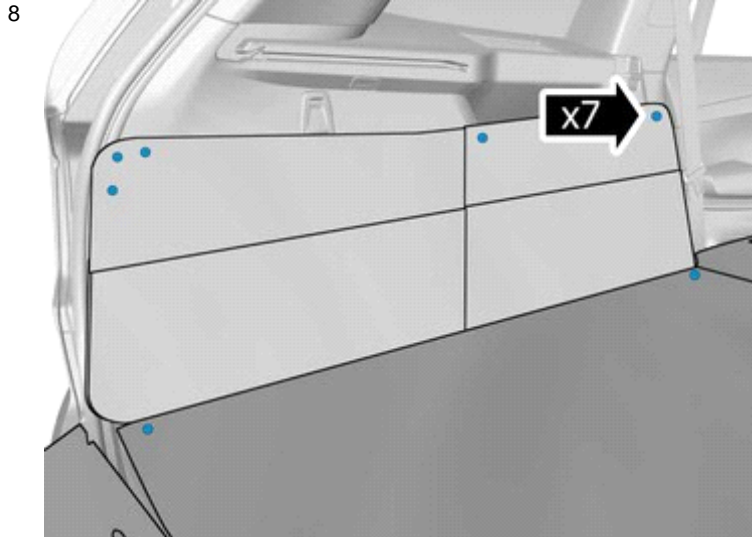

IMG-405671

Note!
Orientation view

Applies to the right-hand side

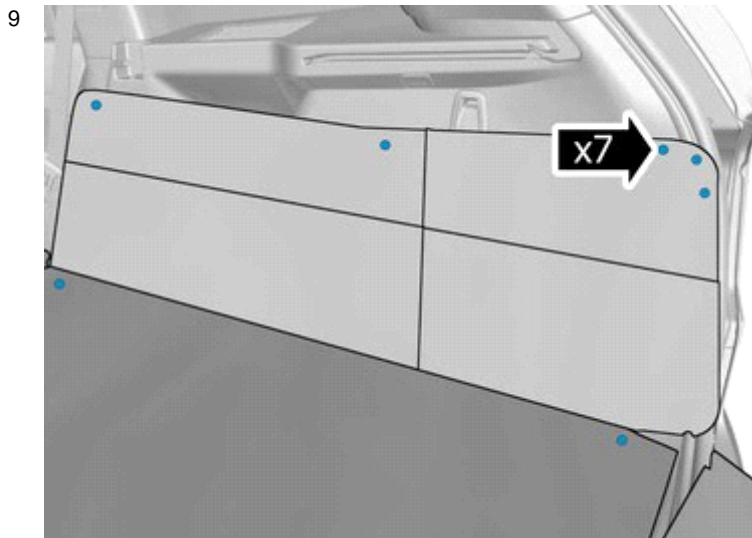

IMG-405674

Note!
Orientation view



Installation instructions, accessories

Volvo Car Corporation Gothenburg, Sweden

10

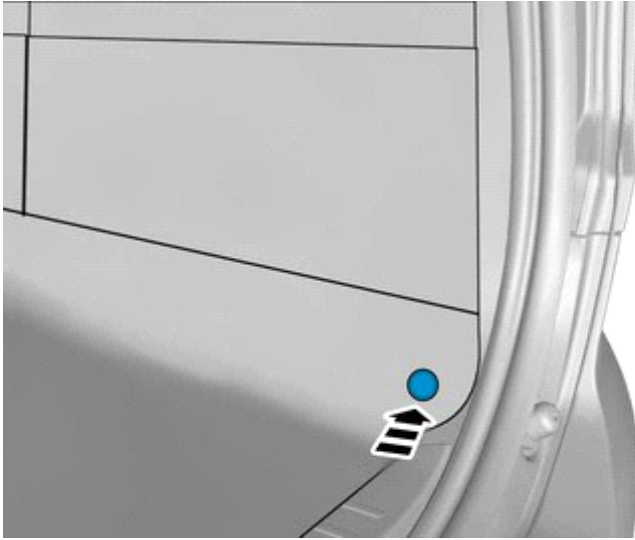

IMG-405375

Press the marked component.

Use hands only.

11

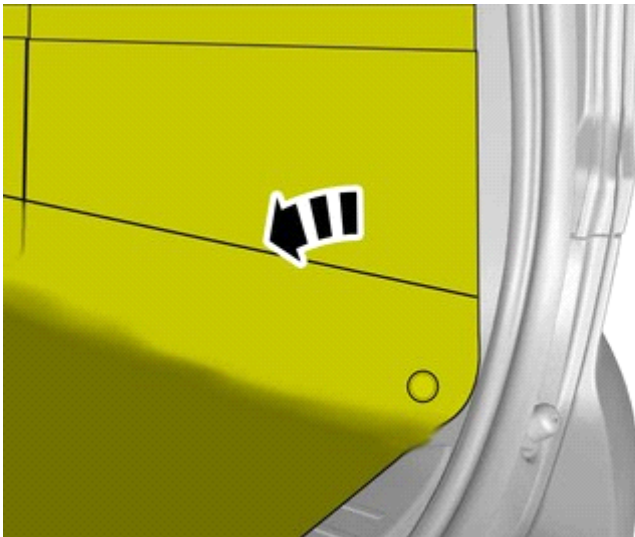

IMG-405391

Fold marked part to one side.

12

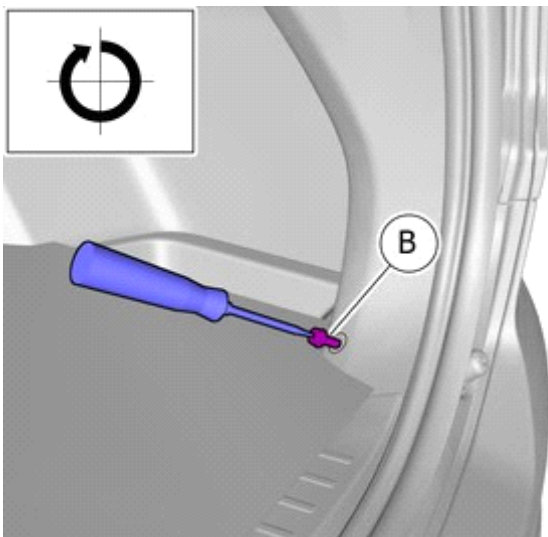

IMG-405392

Install component that comes with the accessory kit.



Installation instructions, accessories

Volvo Car Corporation Gothenburg, Sweden

Applies to the left-hand side:

13

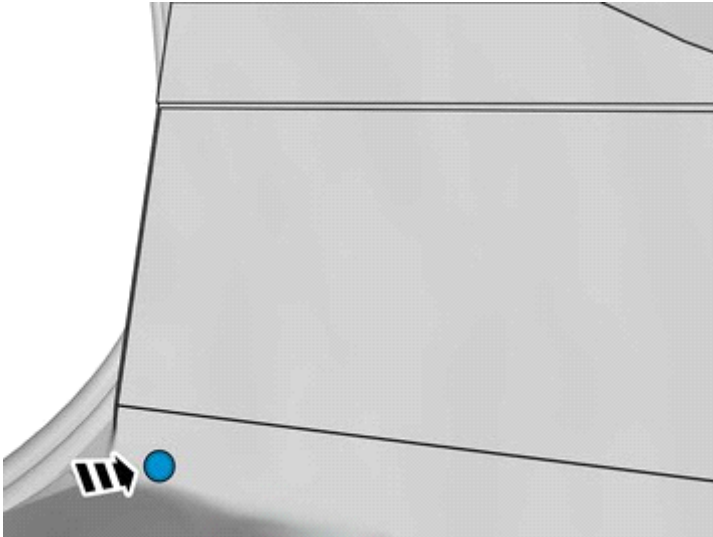

IMG-405298

Press the marked component.

Use hands only.

14

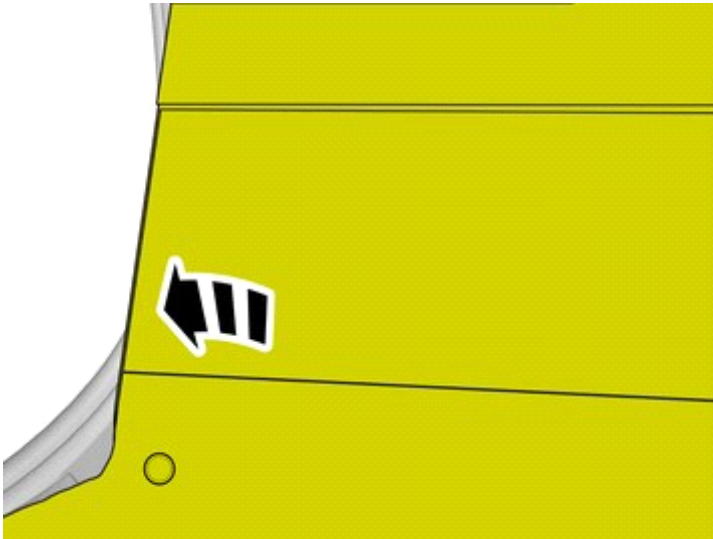

IMG-405299

Fold marked part to one side.



Installation instructions, accessories

Volvo Car Corporation Gothenburg, Sweden

15

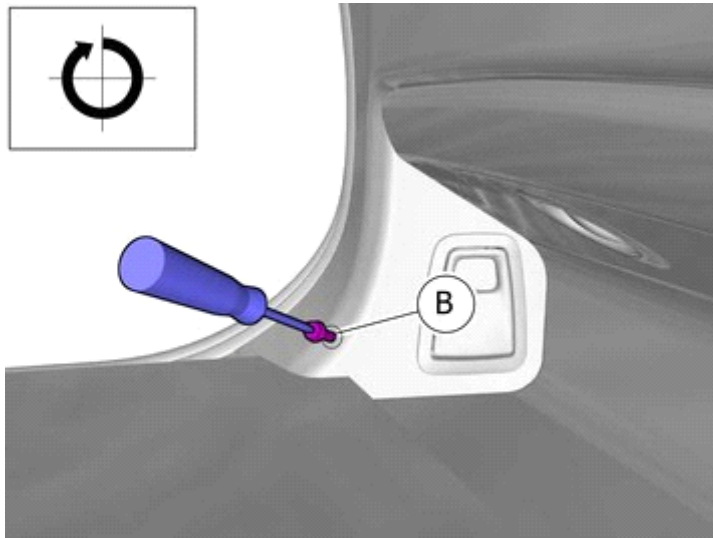

IMG-405306

Install component that comes with the accessory kit.

16

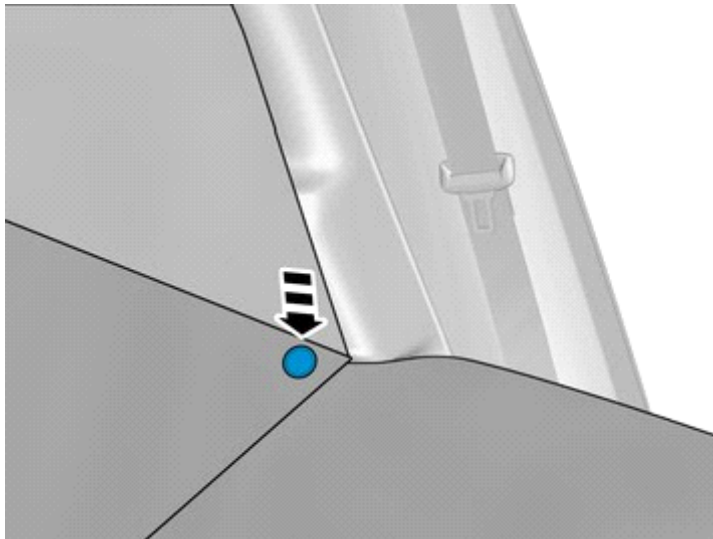

IMG-405315

Press the marked component.

Use hands only.

17

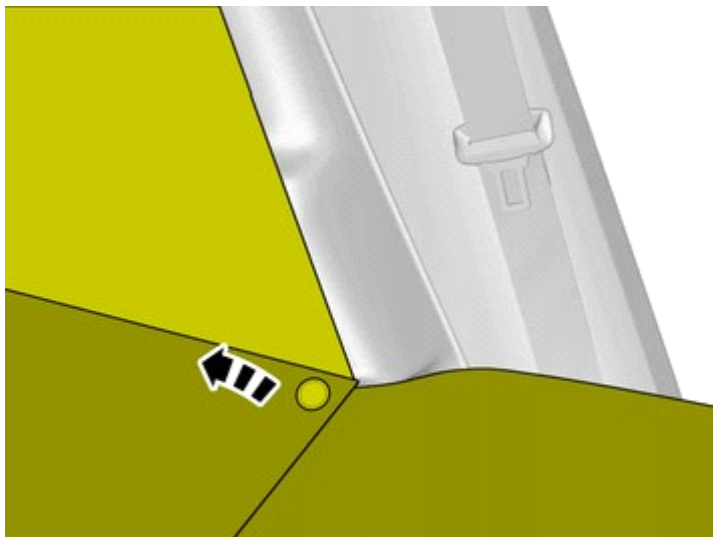

IMG-405320

Fold marked part to one side.



Installation instructions, accessories

Volvo Car Corporation Gothenburg, Sweden

18

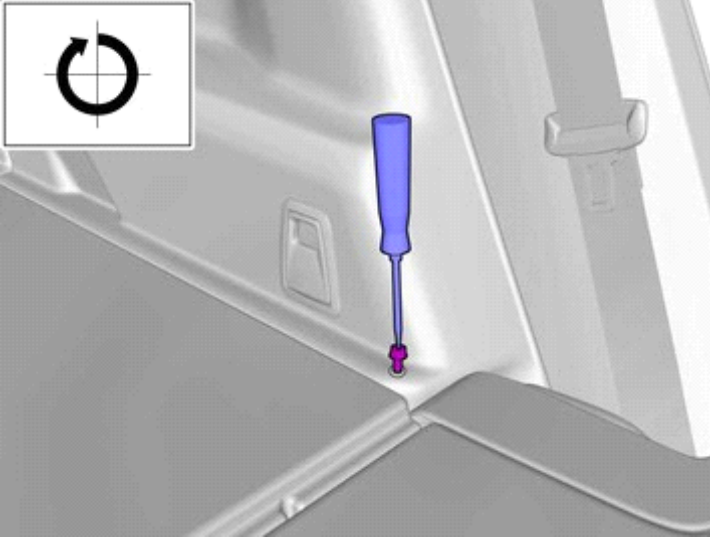

IMG-405321

Install component that comes with the accessory kit.

Applies to the right-hand side

19

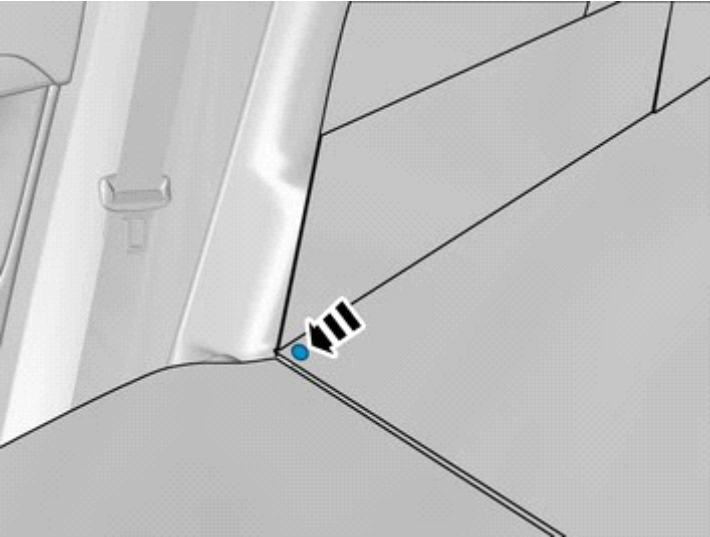

IMG-405421

Press the marked component.

Use hands only.



Installation instructions, accessories

Volvo Car Corporation Gothenburg, Sweden

20

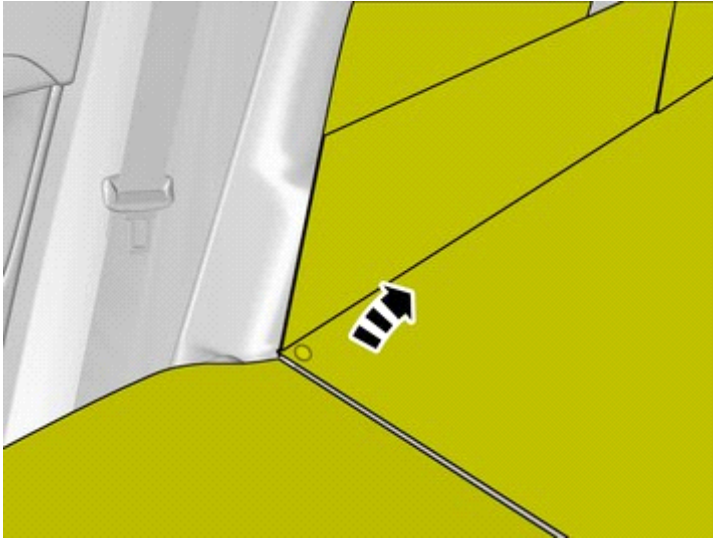

IMG-405422

Fold marked part to one side.

21

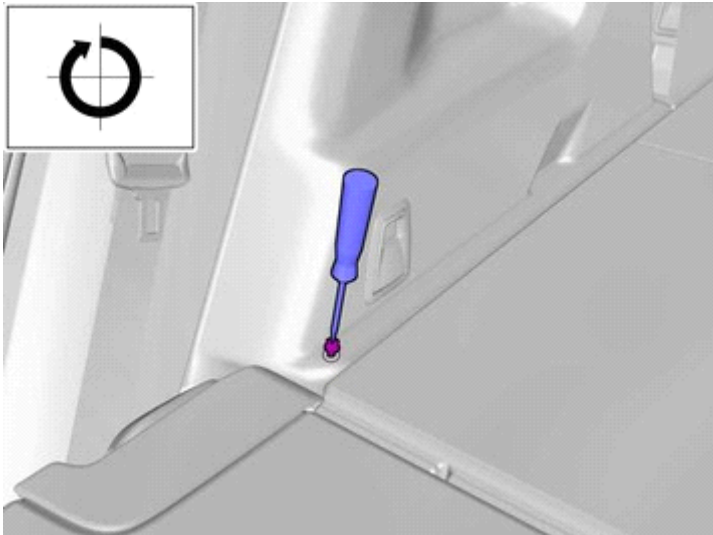

IMG-405423

Install component that comes with the accessory kit.

22

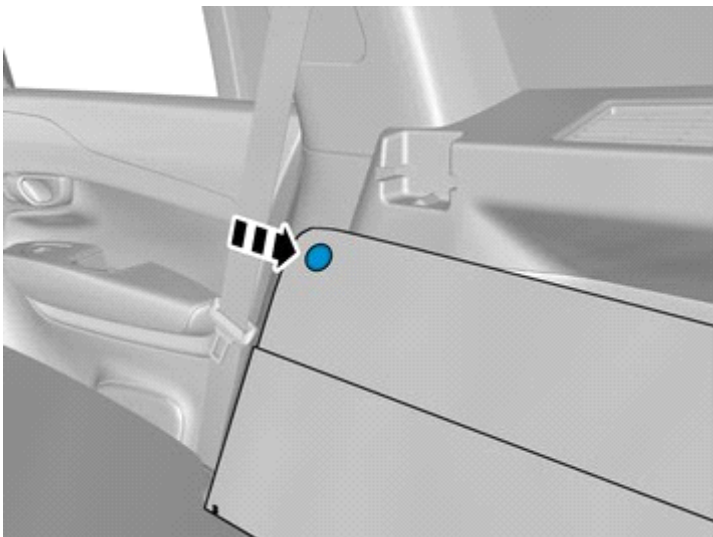

IMG-405441

Press the marked component.

Use hands only.



Installation instructions, accessories

Volvo Car Corporation Gothenburg, Sweden

23

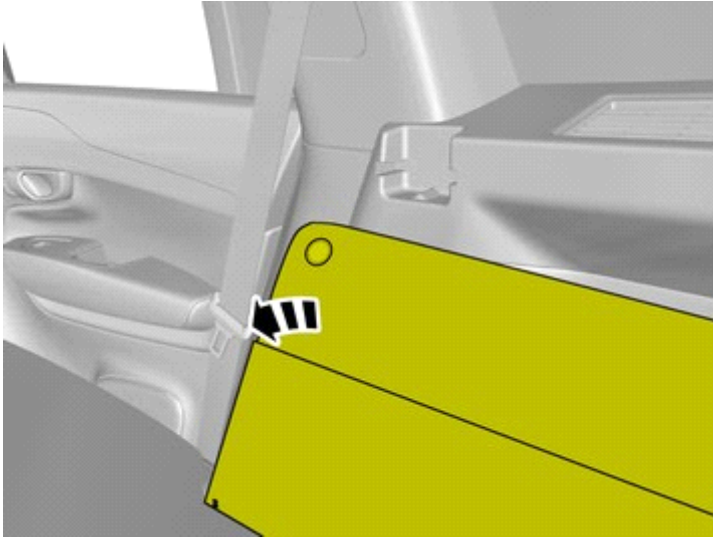

IMG-405445

Fold marked part to one side.

24

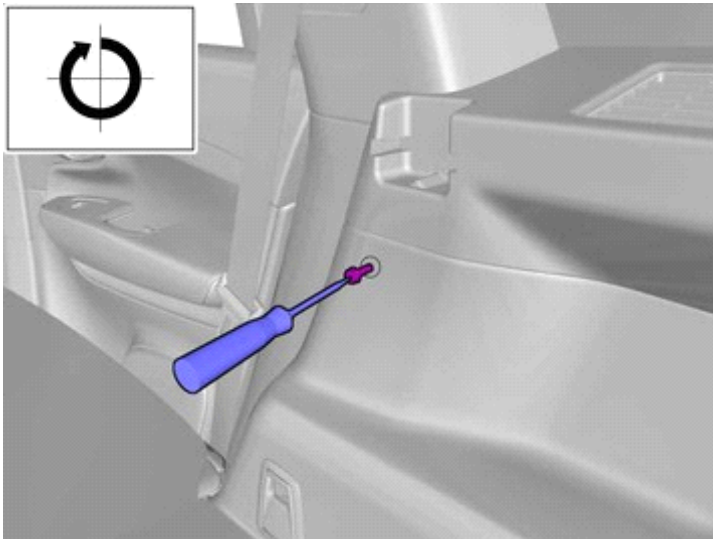

IMG-405450

Install component that comes with the accessory kit.

25

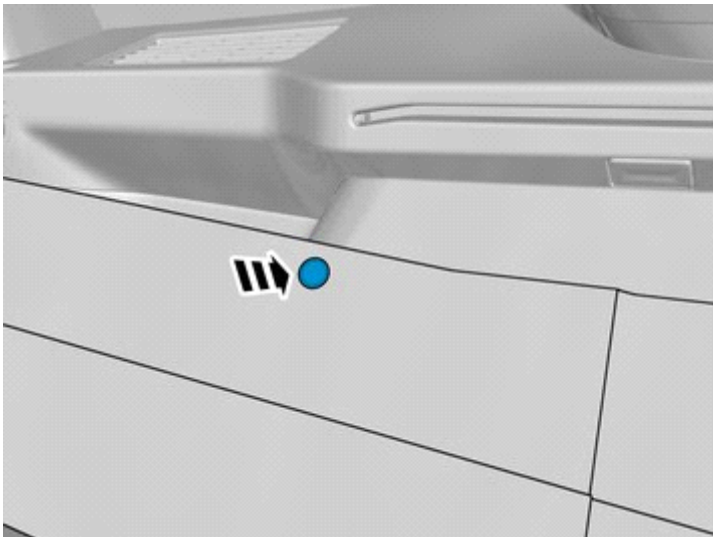

IMG-405458

Press the marked component.

Use hands only.



Installation instructions, accessories

Volvo Car Corporation Gothenburg, Sweden

26

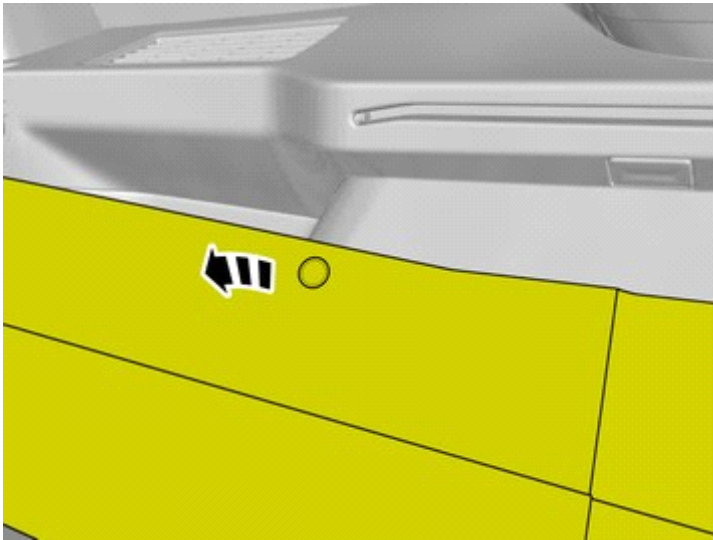

IMG-405457

Fold marked part to one side.

27

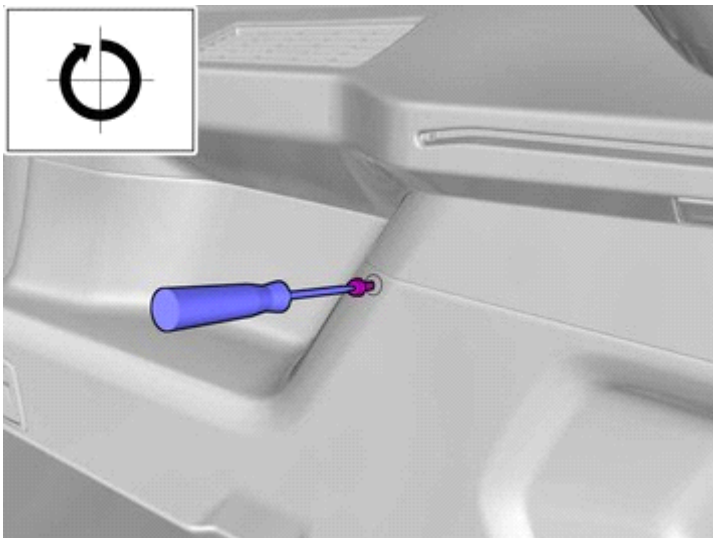

IMG-405461

Install component that comes with the accessory kit.



Installation instructions, accessories

Volvo Car Corporation Gothenburg, Sweden

28



IMG-405464

Press the marked component.

Use hands only.

29

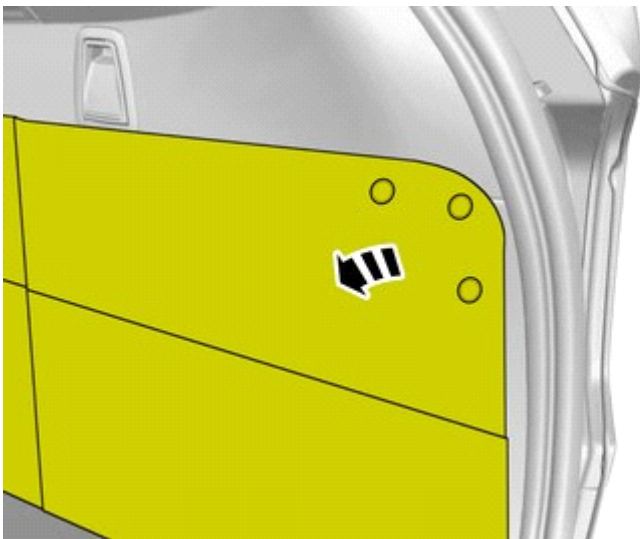

IMG-405463

Fold marked part to one side.

30

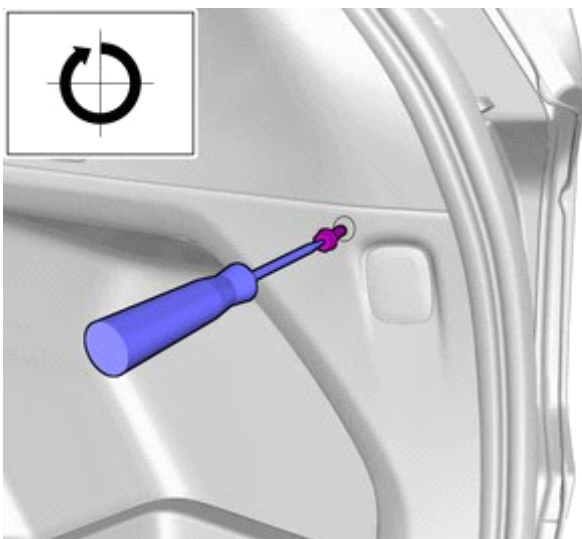

IMG-405466

Install component that comes with the accessory kit.



Installation instructions, accessories

Volvo Car Corporation Gothenburg, Sweden

31

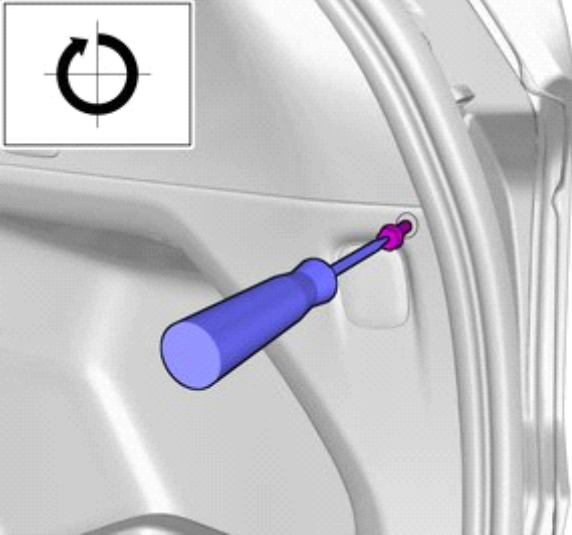

IMG-405467

Install component that comes with the accessory kit.

32

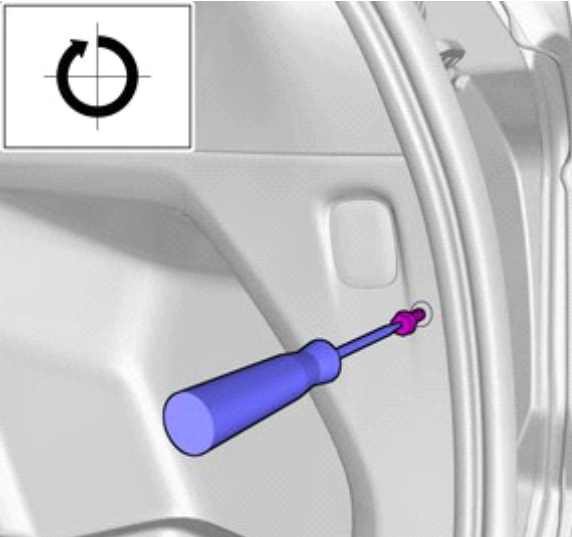

IMG-405468

Install component that comes with the accessory kit.

Applies to the left-hand side:



Installation instructions, accessories

Volvo Car Corporation Gothenburg, Sweden

33

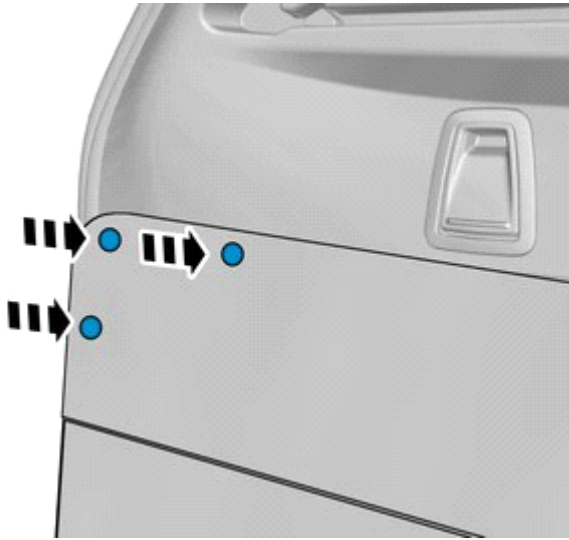

Press the marked component.

Use hands only.

IMG-405276

34



Fold marked part to one side.

IMG-405281

35

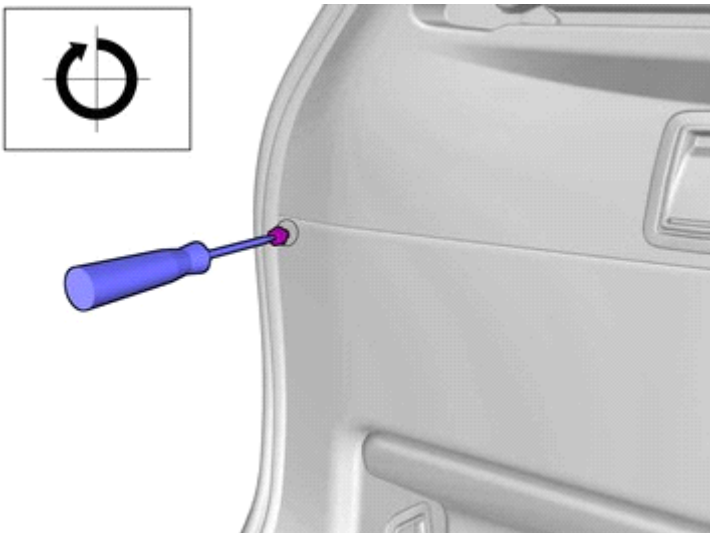

Install component that comes with the accessory kit.

IMG-405277



Installation instructions, accessories

Volvo Car Corporation Gothenburg, Sweden

36

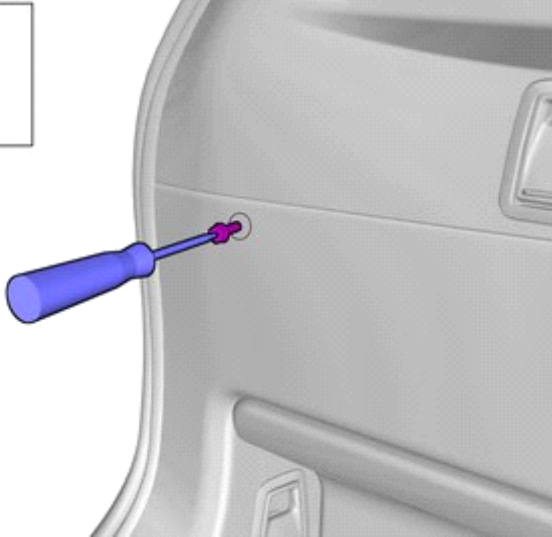

IMG-405279

Install component that comes with the accessory kit.

37

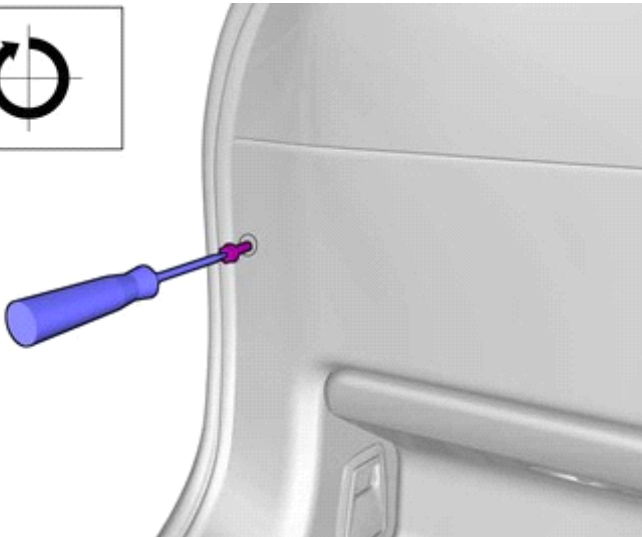

IMG-405280

Install component that comes with the accessory kit.

38

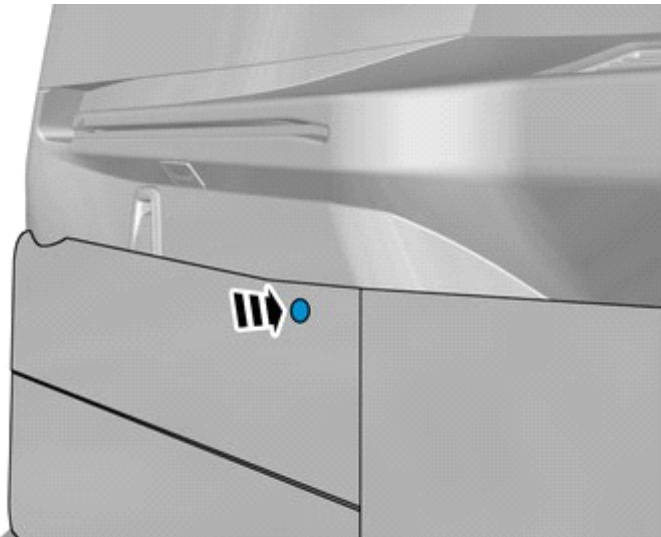

IMG-405220

Press the marked component.

Use hands only.



Installation instructions, accessories

Volvo Car Corporation Gothenburg, Sweden

39

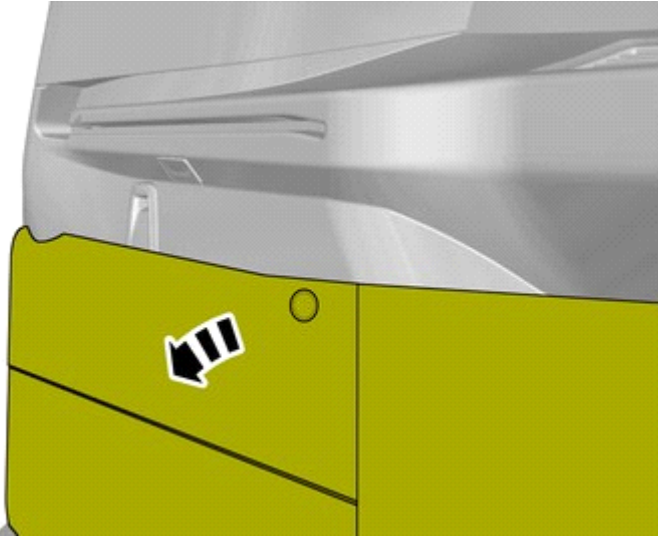

IMG-405221

Fold marked part to one side.

40

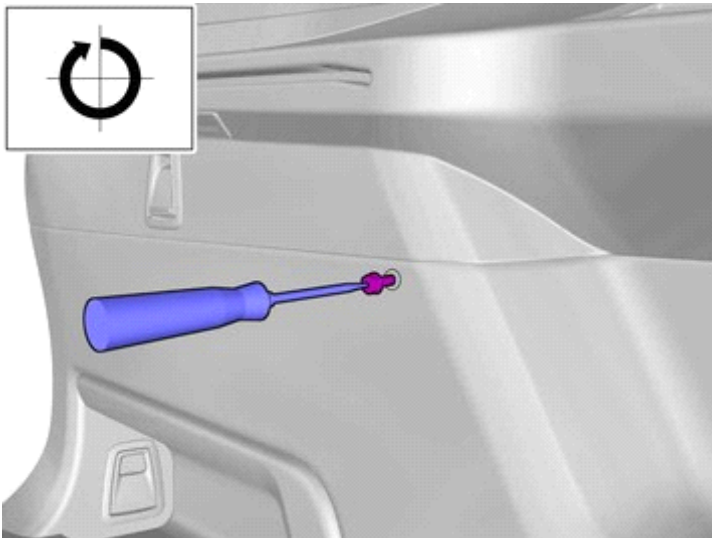

IMG-405222

Install component that comes with the accessory kit.



Installation instructions, accessories

Volvo Car Corporation Gothenburg, Sweden

41



IMG-405231

Press the marked component.

Use hands only.

42



IMG-405232

Fold marked part to one side.

43

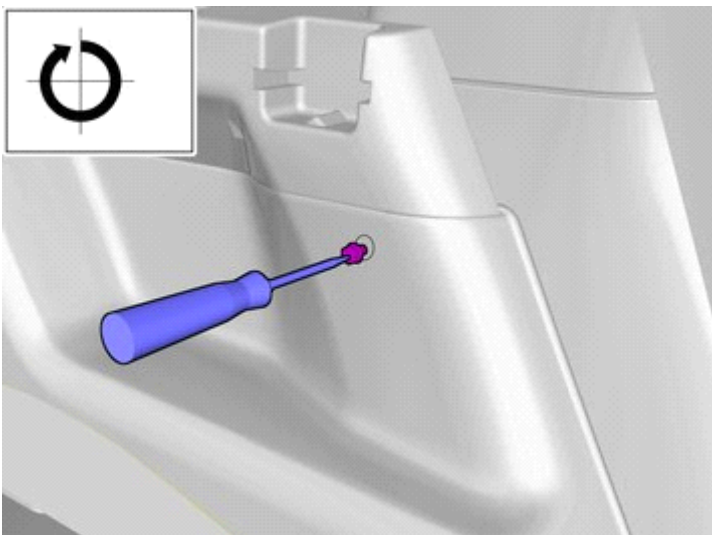

IMG-405233

Install component that comes with the accessory kit.



Installation instructions, accessories

Volvo Car Corporation Gothenburg, Sweden

Vehicles with protective grille, steel

44

To access cargo anchor.

Applies to the right-hand side

45

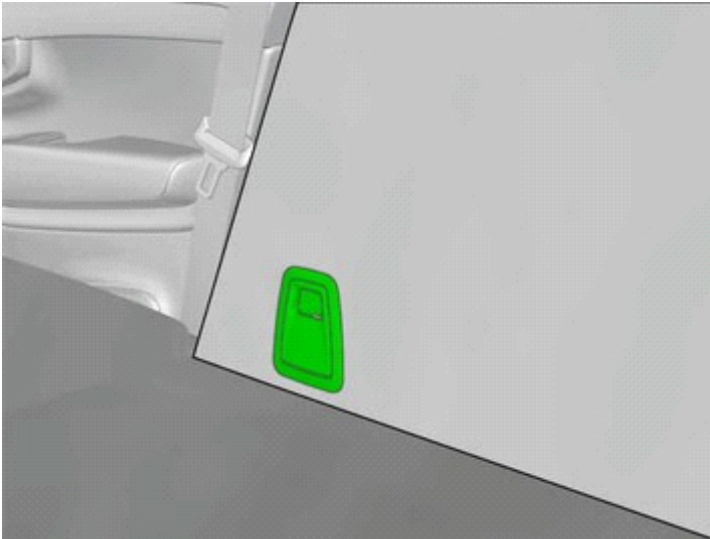

IMG-408500

Note!
Orientation view

46

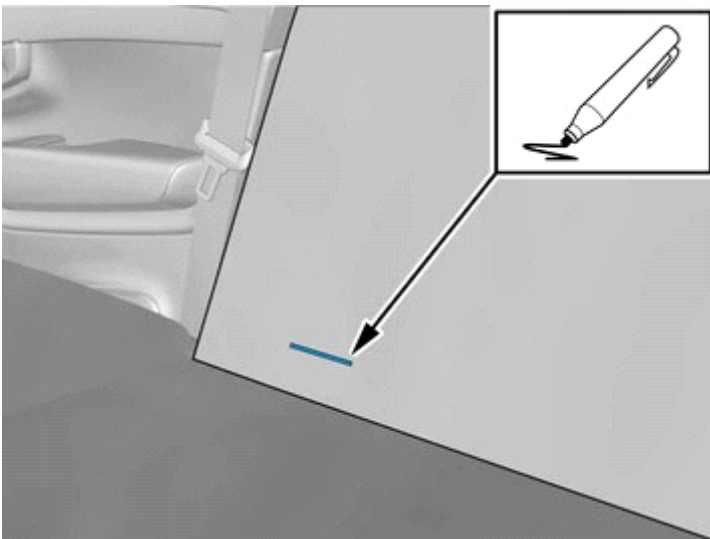

IMG-409477

Measure and mark as illustrated.



Installation instructions, accessories

Volvo Car Corporation Gothenburg, Sweden

47

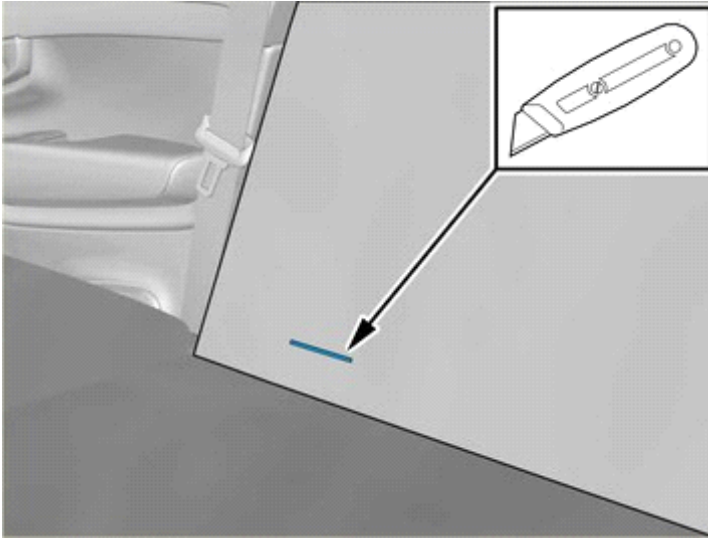

IMG-405610

Cut the component following the instructions in the graphic.

Applies to the left-hand side:

48

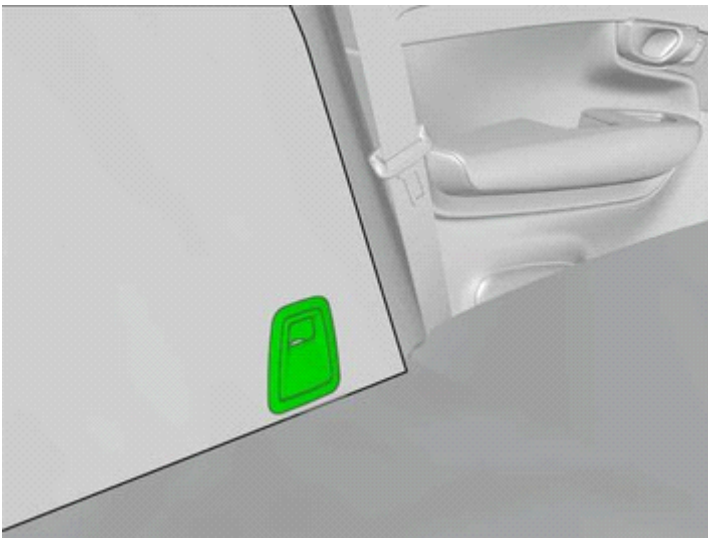

IMG-408501

Note!
Orientation view



Installation instructions, accessories

Volvo Car Corporation Gothenburg, Sweden

49

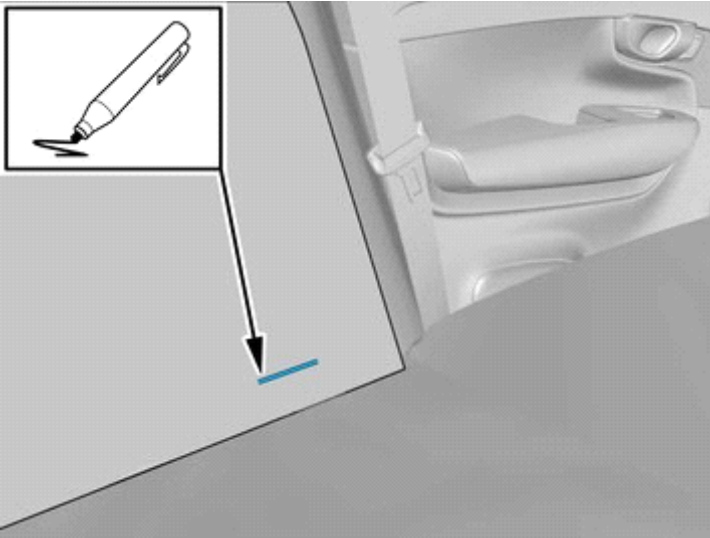

IMG-409490

Measure and mark as illustrated.

50

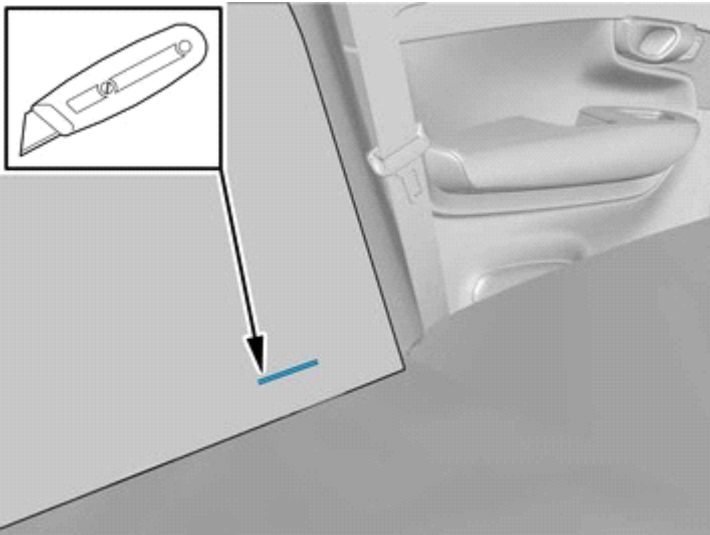

IMG-405611

Cut the component following the instructions in the graphic.

Vehicles with longitudinal load compartment divider



Installation instructions, accessories

Volvo Car Corporation Gothenburg, Sweden

51

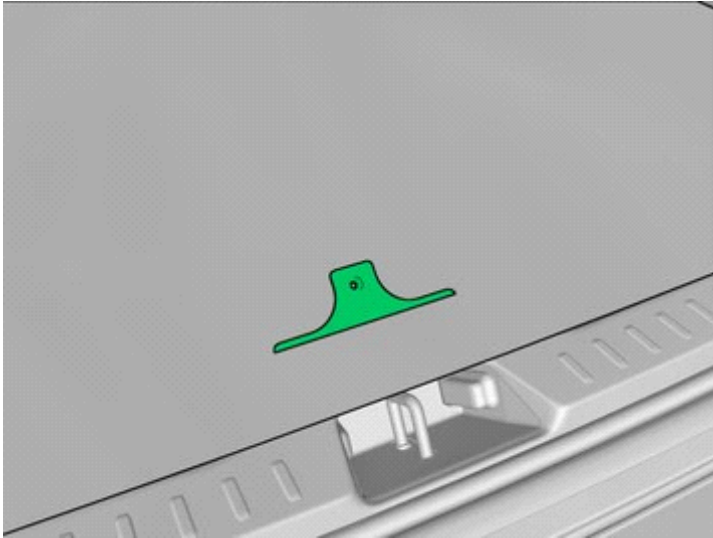

IMG-405905

Note!
Orientation view

52

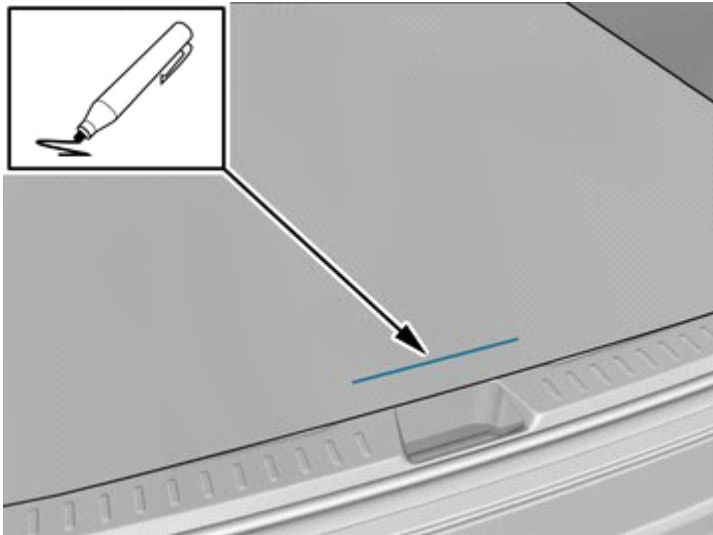

IMG-409495

Measure and mark as illustrated.

53

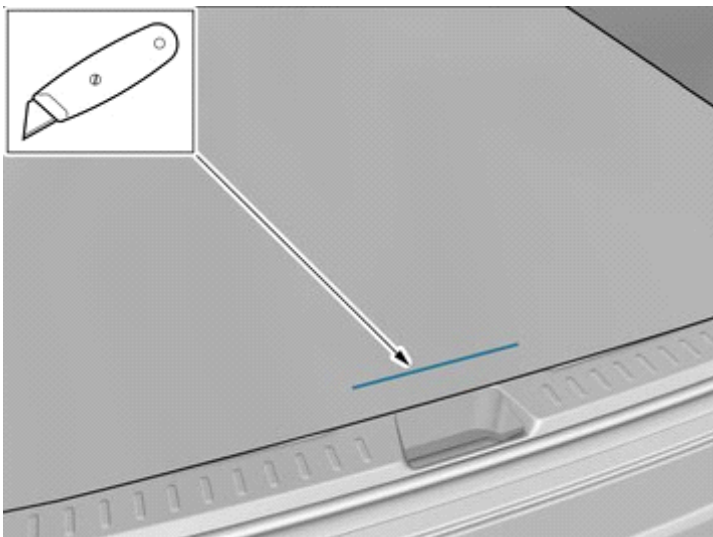

IMG-405541

Cut the component following the instructions in the graphic.



Installation instructions, accessories

Volvo Car Corporation Gothenburg, Sweden

Vehicles with dog gate

54

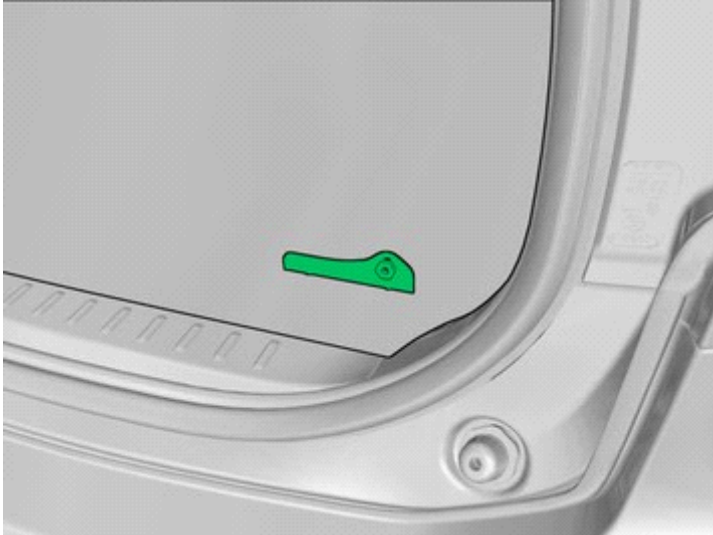

IMG-405720

Note!

Orientation view

55

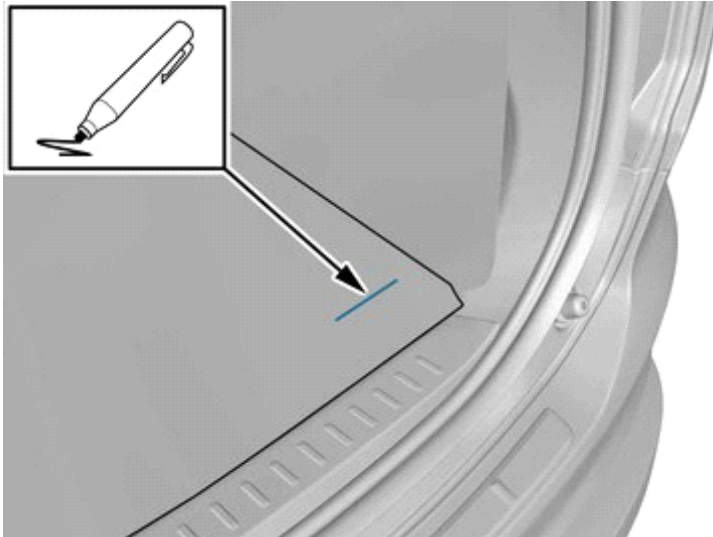

IMG-409496

Measure and mark as illustrated.



Installation instructions, accessories

Volvo Car Corporation Gothenburg, Sweden

56

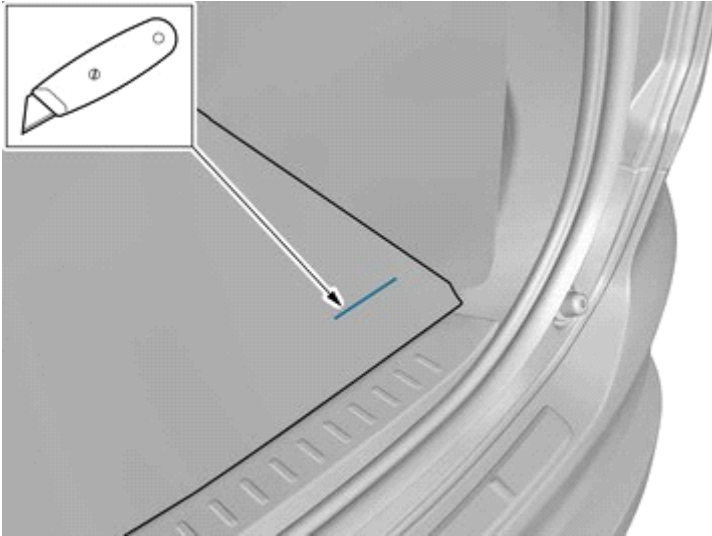

IMG-405566

Cut the component following the instructions in the graphic.

57

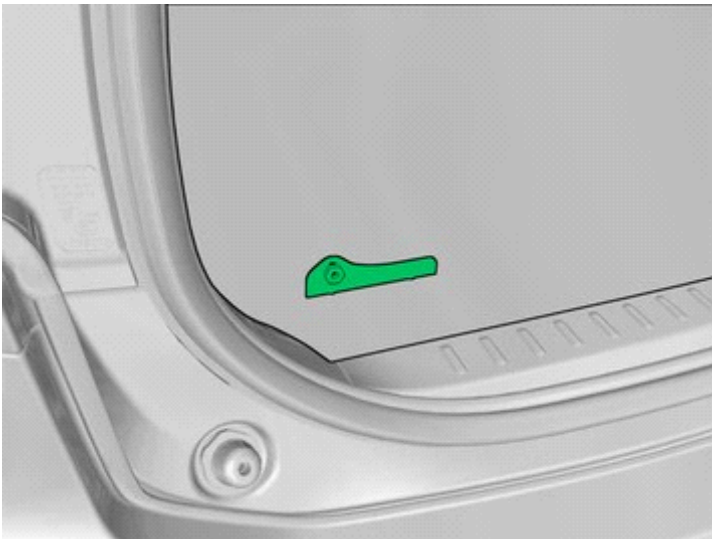

IMG-405721

Note!
Orientation view

58

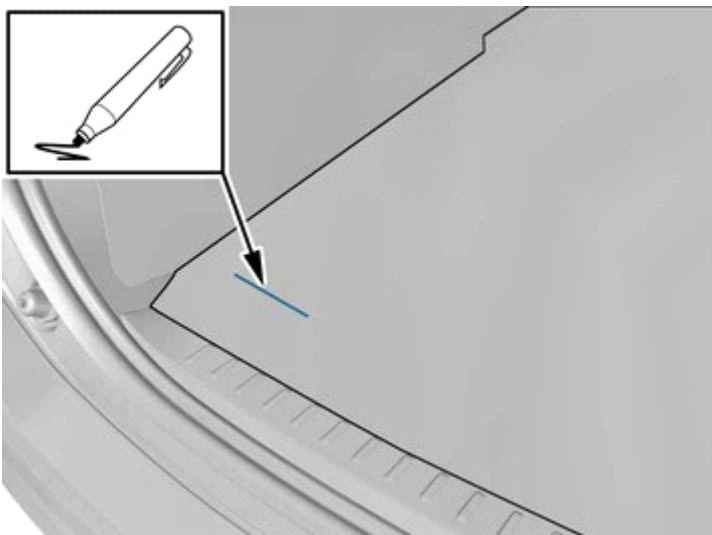

IMG-409497

Measure and mark as illustrated.



Installation instructions, accessories

Volvo Car Corporation Gothenburg, Sweden

59

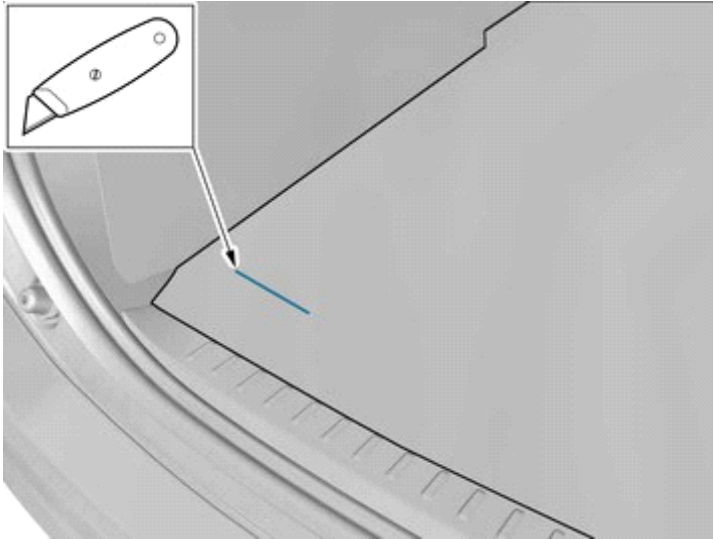

IMG-405630

Cut the component following the instructions in the graphic.

Vehicles with folding towbar

60

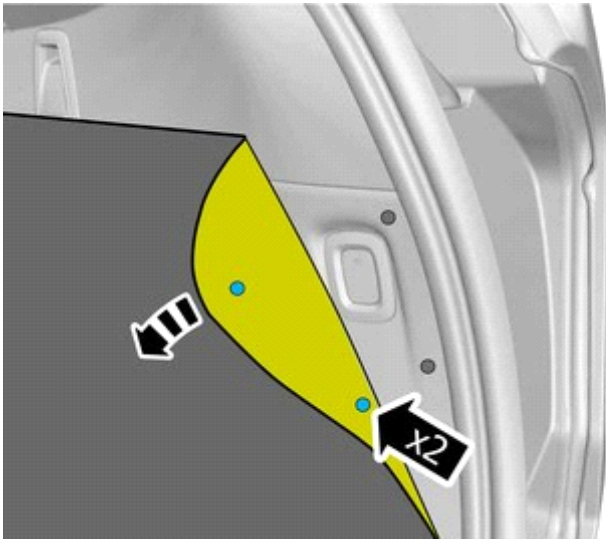

IMG-409515

Vehicles with air suspension



Installation instructions, accessories

Volvo Car Corporation Gothenburg, Sweden

61

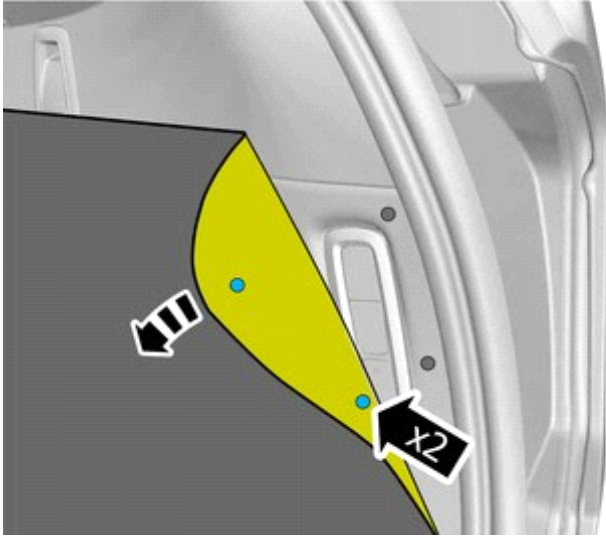

IMG-409521

All vehicles

62

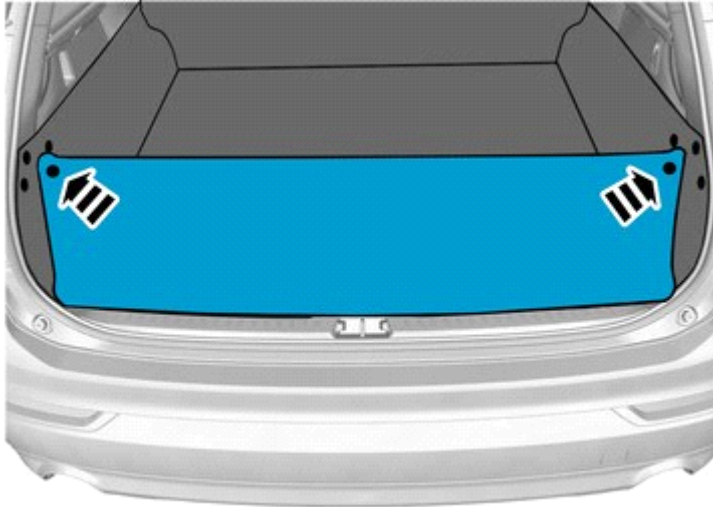

IMG-409475

Allow the Bumper Protection to adhere to the Bumper Cover as indicated.